

INSTALLATION INSTRUCTIONS
RWS-Y-RMAX4: Rear Poly Windshield

- Ⓢ Please look through and read these instructions BEFORE starting so you understand what processes you'll be doing, and possible extra tools you may need.
- Ⓢ Do Not discard product packaging until installation is complete and functioning properly.

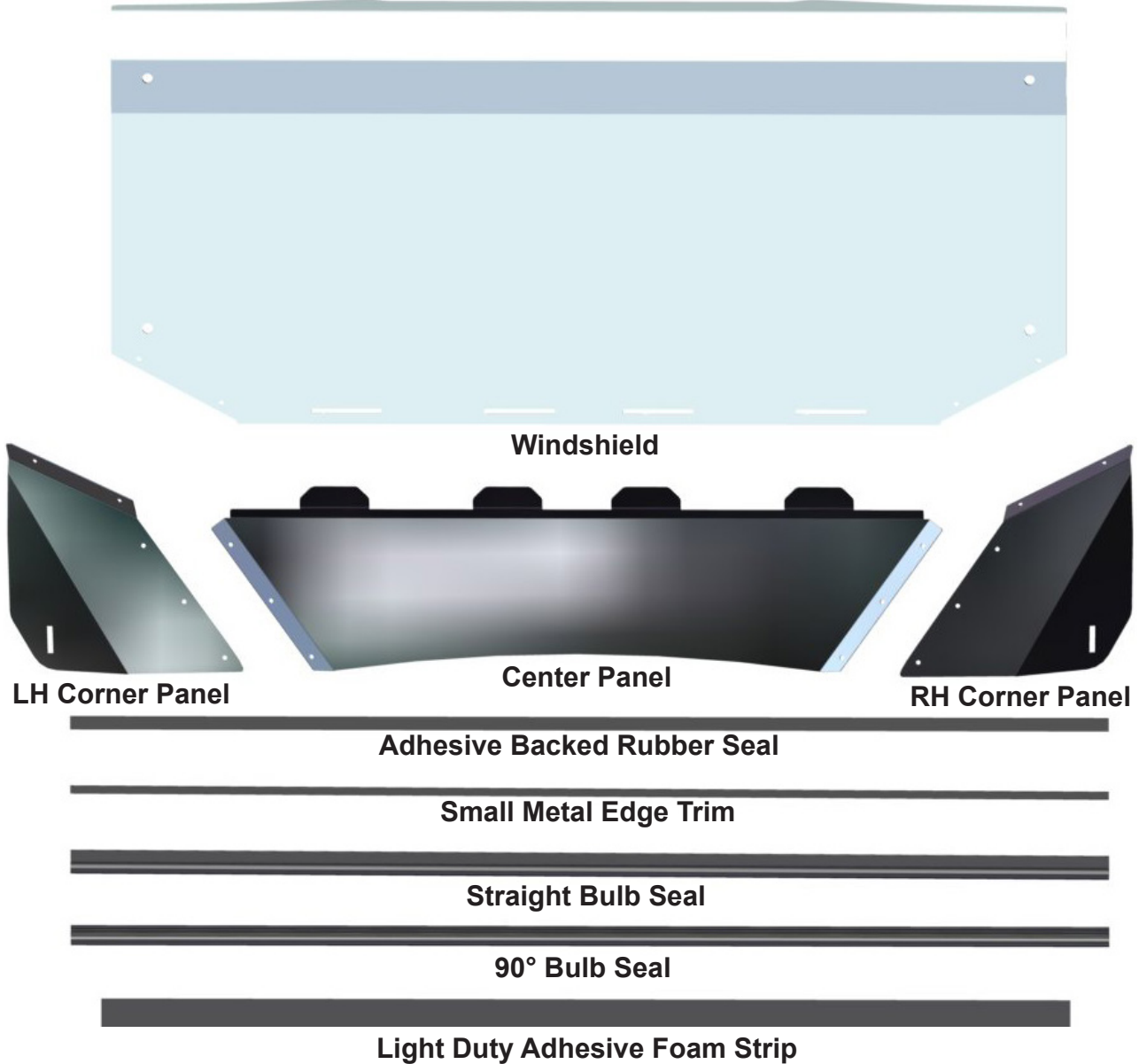

1. The first thing you need to do is **Remove** the **Grommets** from the Clamps that came in your kit, as you will need to **Insert** them into the holes in the **Windshield** for the clamps to attach to. **Fig.1a** shows where they will go, and **Fig.1b** shows one side of the windshield with the Grommets inserted in place.

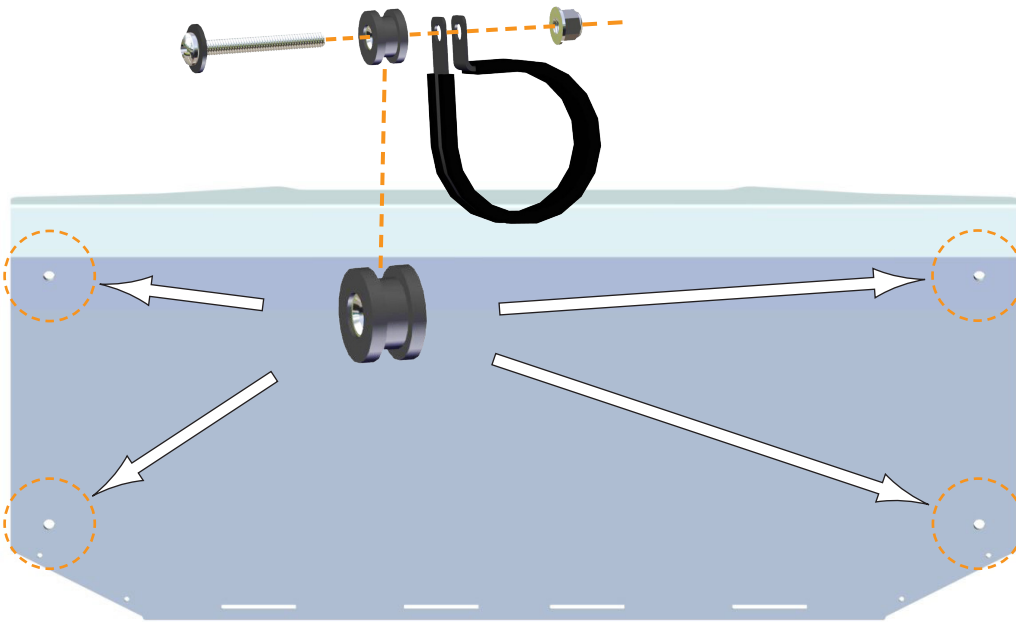

Fig.1a



Fig.1b

2. Next you will need to **Insert** the metal **Center Panel**. There are **Four (4) Slots** cut out in the Windshield that you insert the tabs on the metal panel into. Insert them at an angle then lower to let the panel rest, interlocked in the Windshield. **Fig.10a-c** show this process.

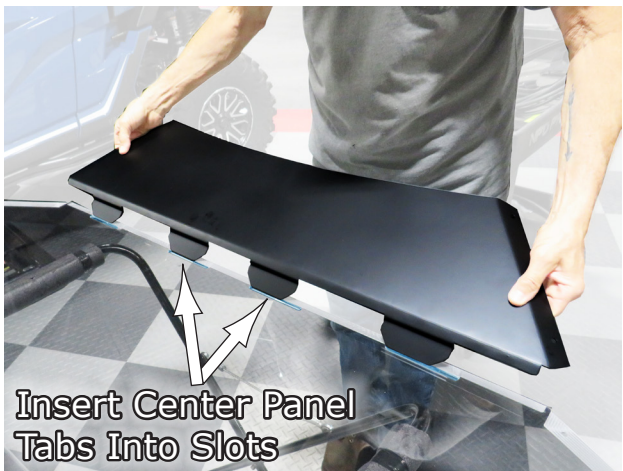

Fig.2a



Fig.2b

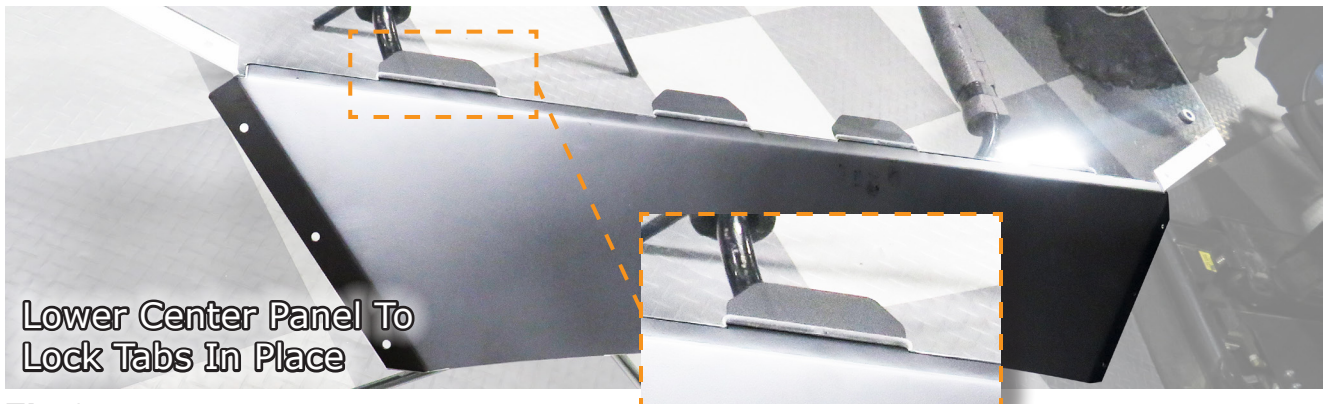
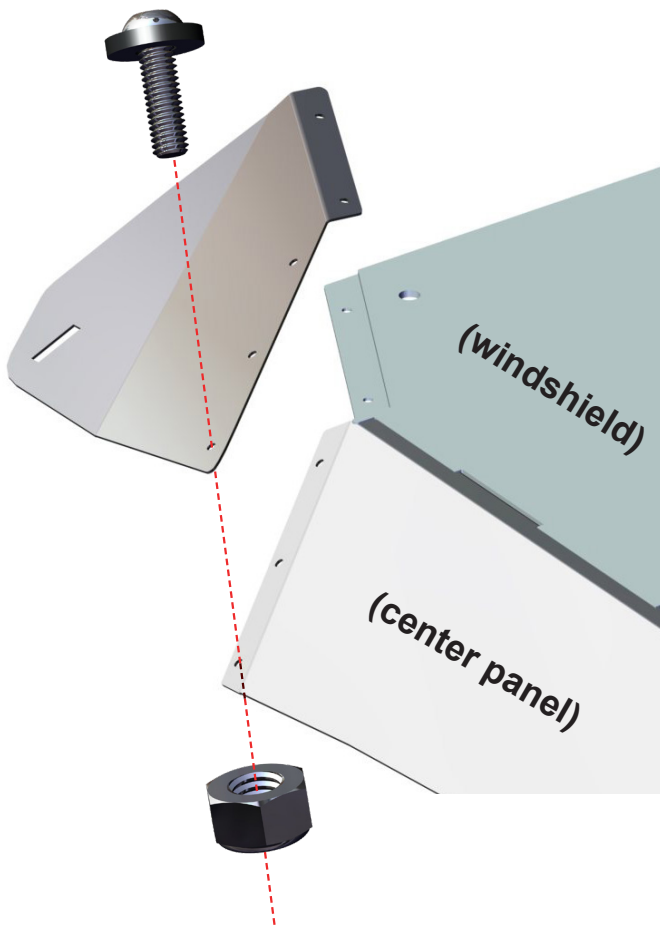

Fig.2c

3. Once the Center Panel is in place, you can now **Install the Corner Panels** onto each side using the **M6x20 Button FT Sealing Screws** and **M6 Nylock Nuts** in your kit. These will lay over the Windshield and Center Panel on ea. corner, then screw together using the hardware. Then repeat the same procedure for the opposite corner. See **Fig.3a-c**.



Install Corner Panels Using M6x20 Button Ft Screws & M6 Nylock Nuts
Fig.3a



Install M6 Nylock Nuts
Fig.3b



Corner Panel Installed
Fig.3c



NOTE: All Seals in this kit are “Cut-To-Fit” for the areas applying to.

4. Now you need to **Apply** the **90° Bulb Seal** to the Edges of the Windshield by pressing the open edge of the bulb over the side edges of the windshield as shown in **Fig.4a-c**. It also may help to lightly tap along the edge to seat it firmly against the windshield edge. Apply to both Left & Right edges. See **Fig.4a-c**.



Fig.4a

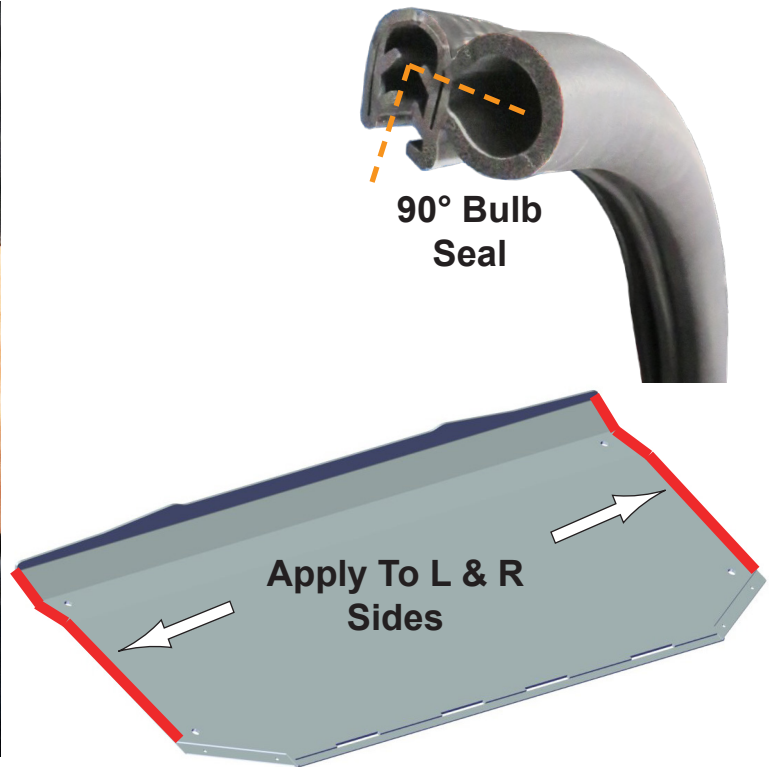

Fig.4b



Fig.4c

5. Next **Install the Straight Bulb Seal** that get applied to the **Top Edge** of the **Windshield**. Push it onto the windshield edge just like the 90° you just installed, and tap along the edges to fit snug up against the edge. See **Fig.5a-d**.



Fig.5a



Fig.5b



Fig.5c

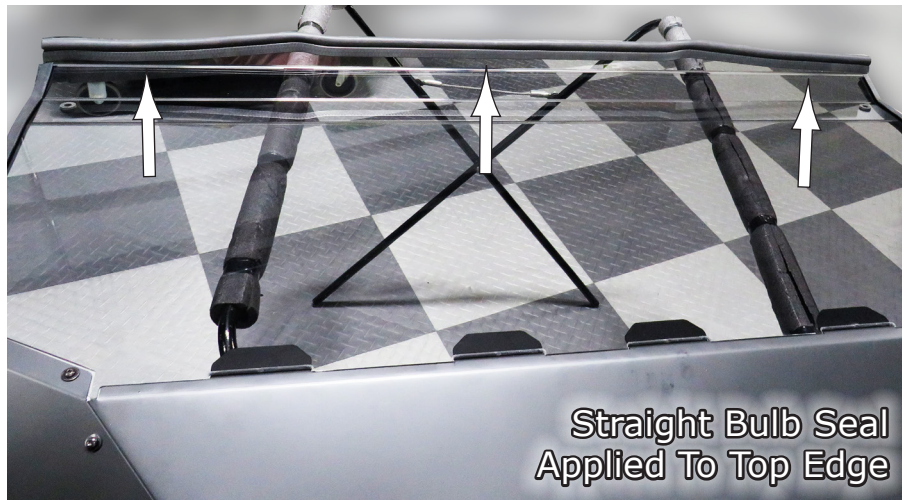

Fig.5d

6. After the top seal is applied, you can now **Install the Small Metal Edge Trim** along the bottom edge of the metal panels you previously installed. We installed ours starting in the center working out towards one side, then center towards the other side. See **Fig.6a-c**.

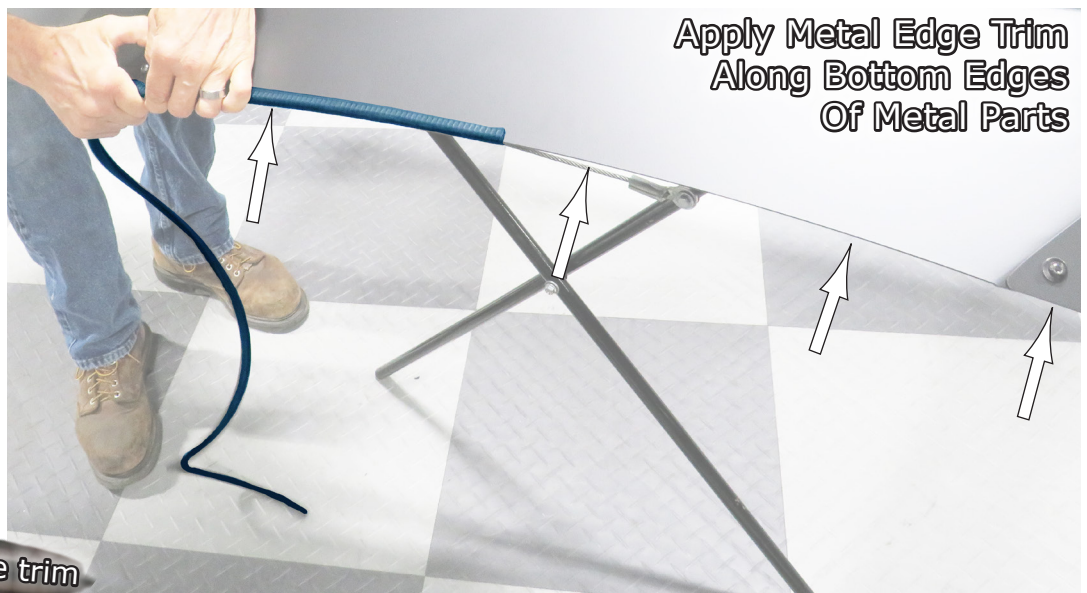

Fig.6a



Fig.6b

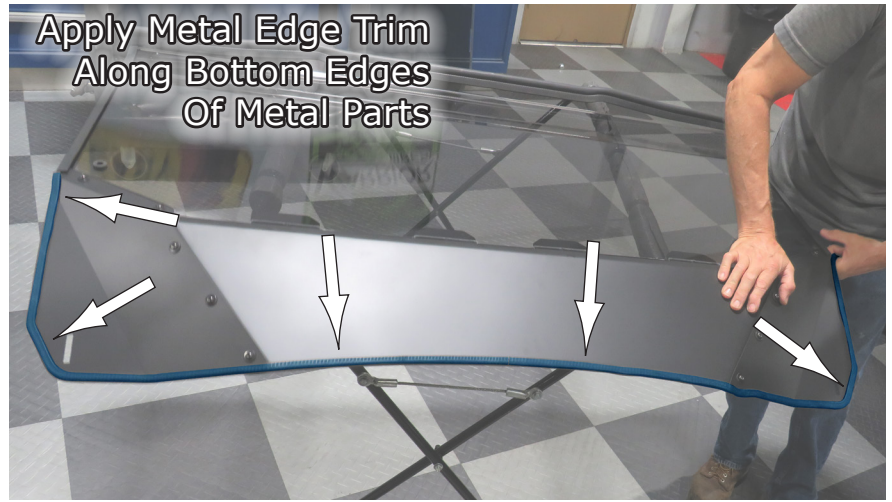

Fig.6c

7. The next thing is to **Install the Velcro Straps** onto the Windshield which will hold the bottom of the windshield to the frame. **Fig.7a** shows the **Slots** in each Left & Right lower corners of the Metal Panels. Then find the **Velcro Straps** and feed the end of the strap thru the slot with the Hook/Loop facing upwards as shown in **Fig.7b-d**. Be sure your left & right side straps are oriented like the ones shown.



Fig.7a



Fig.7b



Fig.7c



Fig.7d

8. After the Straps are in the Windshield, it is ready to install. So first, you need to **Raise the Rear Bed** up all the way as shown in **Fig.8a**. Then **Slide the Windshield Thru** to the other side making sure that the bottom edge goes in front of the cargo bed protective tray at the bottom, and that the top edge of the windshield with the bulb seal will fit up against the inside of the roof overhang. See **Fig.8a-e**.



Fig.8a



Fig.8b



Fig.8c



Fig.8d

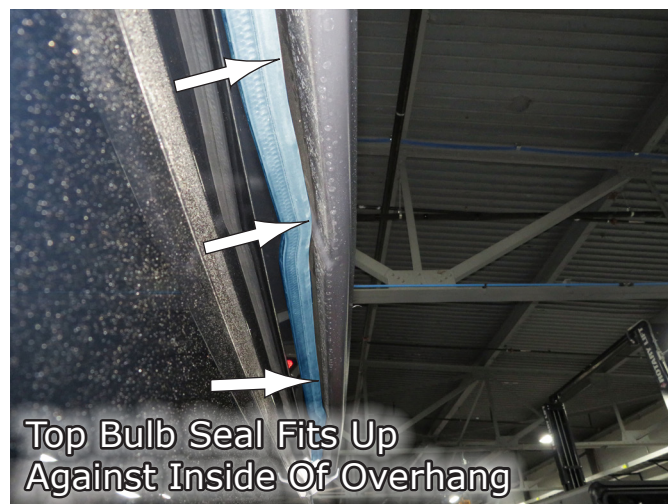

Fig.8e

9. Now you need to **Wrap** the **Straps** around the frame to temporarily hold the windshield in place. Do not tighten down yet as you will need to loosen and adjust the fit of the windshield to the vehicle. This is to hold it in place while you install the windshield clamps first. **Fig. 9a-d** shows how to wrap the straps to the vehicle.

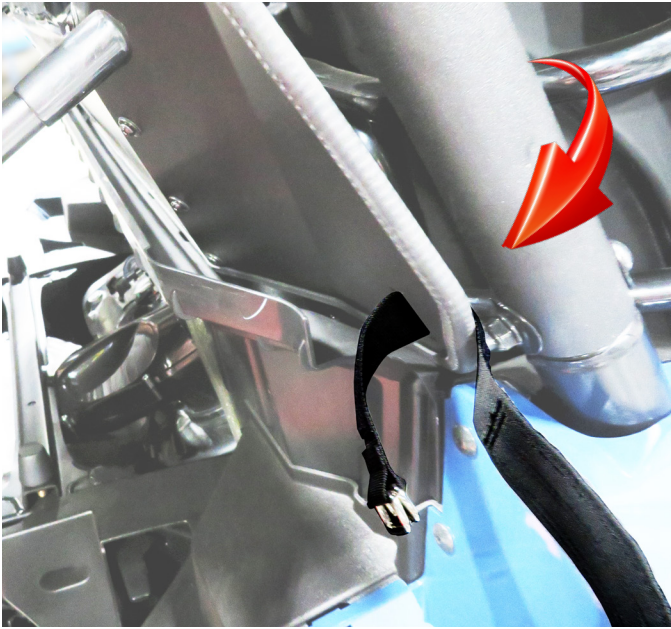

Fig.9a



Fig.9b



Fig.9c

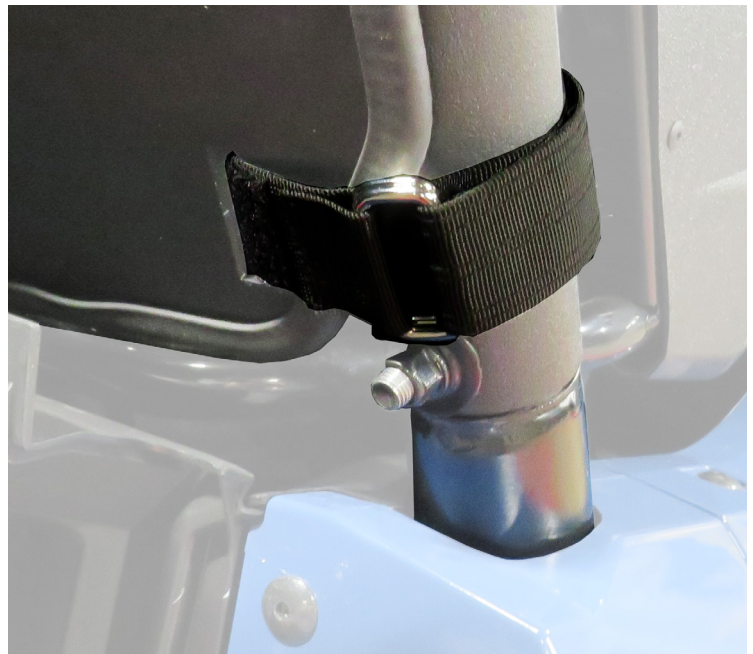

Fig.9d



10. Once you have the Windshield in place and strapped at the bottom, you can now get ready to **Install** the **Clamps**. To do that, find the clamps and **Remove** the **Rubber Grommets** from the clamp assemblies. See **Fig.10**.

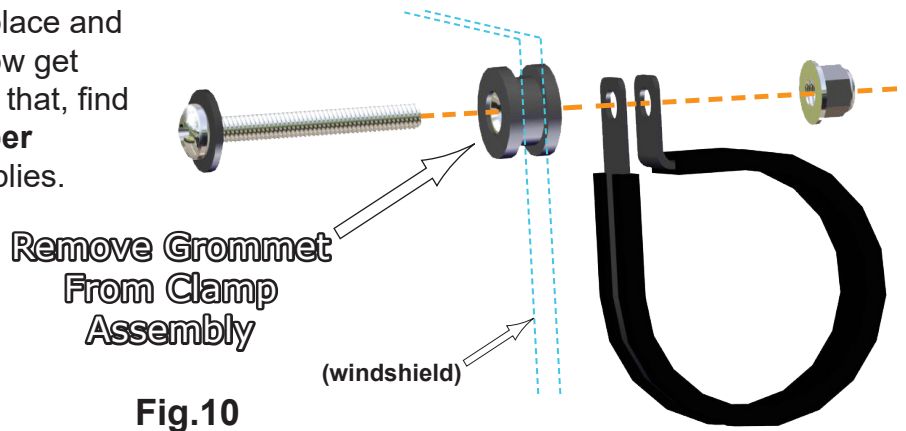

Fig.10

11. Now you need to **Insert** the **Grommets** into the holes provided in the Windshield in each corner where you will be hooking the Clamps to. See **Fig.11a-b**. Then **Attach** the **Clamps** around the frame bar with the **Flat Part** of the clamp towards the window. Then **Install** the **Screw & Lock Nut** that was with the clamp as shown in **Fig.11c-d**. Snug but don't tighten yet. Install all Four (4) clamps this way. Then make any adjustments to the windshield until the desired position. After you are satisfied, then go back and tighten down all Clamps, and then re-tighten both of the Straps to secure as well. Also see **Fig.10** for Clamp assembly through the windshield.



Fig.11a



Fig.11b

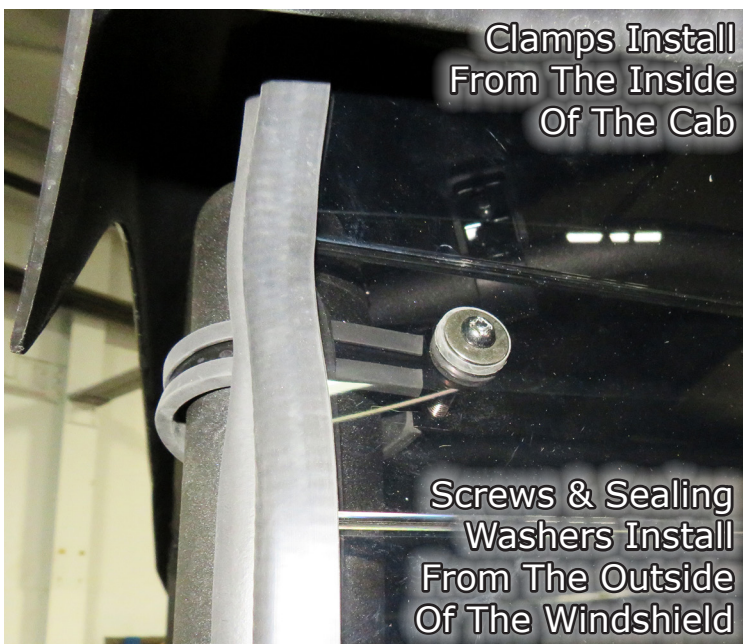

Fig.11c



Fig.11d



Liability Statement

SuperATV's® products are designed to best fit user's ATV/UTV under stock conditions. Adding, modifying, or fabricating any factory or aftermarket parts will void any warranty provided by SuperATV® and is not recommended. SuperATV's® products could interfere with other aftermarket accessories. If user has aftermarket products on machine, contact SuperATV® to verify that they will work together.

Although SuperATV® has thousands of satisfied customers, user should be aware that installing lift kits, long travel, or suspension kits, tires, etc. will change the ride of machine and may increase maintenance and part wear. Operating any off-road machine while, or after, consuming alcohol and/or drugs increases risk of bodily harm or death. No warranty or representation is made as to this product's ability to protect user from severe injury or death. SuperATV® urges operators and occupants to wear a helmet and appropriate riding gear at all times.

By purchasing and installing SuperATV® products, user agrees that should damages occur, SuperATV® will not be held responsible for loss of time, use, labor fees, replacement parts, or freight charges. SuperATV®, nor any 3rd party, will not be held responsible for any direct, indirect, incidental, special, or consequential damages that result from any product purchased from SuperATV®. The total liability of seller to user for all damages, losses, and causes of action, if any, shall not exceed the total purchase price paid for the product that gave rise to the claim.

SuperATV® will warranty only parts provided by SuperATV®. Any damage or problems with OEM housings, bearings, seals, or other manufacturers' products will not be covered by SuperATV®. SuperATV® parts and products are not warranted if item was not installed properly, misused, or modified.

Installing, adding, modifying, or fabricating any factory or aftermarket product to your ATV/UTV may violate certain local, state, and federal laws. Be advised that laws vary depending on town, city, county, state, etc. Use of certain products on public streets, roads, or highways may be in violation law. The Buyer is solely and exclusively legally and personally responsible for any violation of the law by the installation or use of the product. You must abide by all local, state, and federal laws, including but not limited to vehicle safety, traffic laws, and ordinances. It is your responsibility to know the laws and how they apply to you.

The Buyer is responsible to fully understand the capability and limitations of his/her vehicle according to manufacturer specifications, warnings and instructions and agrees to hold SuperATV® harmless from any damage resulting from failure to adhere to such specifications, warnings and/ or instructions. The Buyer is also responsible to obey all applicable federal, state, and local laws and ordinances when operating his/her vehicle while using this product, and the Buyer agrees to hold SuperATV® harmless from any violation thereof.

If you have any problems/questions on this kit, contact us by email at [Superatv.com](mailto:sales@superatv.com).

Need help with your installation?



sales@superatv.com



www.superatv.com



1-855-743-3427



8:00am - 9:00pm EST M-Th
8:00am - 7:00pm EST Friday
9:00am - 2:00pm EST Saturday

*Thank You
For Choosing*



Like SuperATV on Facebook to keep up to date on new products!